

Glasdon FireSafe™ Automatic Suppression Device (1kg)

Operating Manual

NOTE: ENSURE THAT ALL RELEVANT PERSONNEL READ THE POINTS LISTED WITHIN THIS LEAFLET AND THAT A COPY IS GIVEN TO STAFF INVOLVED WITH THE INSTALLATION AND MAINTENANCE OF THIS PRODUCT

INSPECTION/MAINTENANCE CHECKS

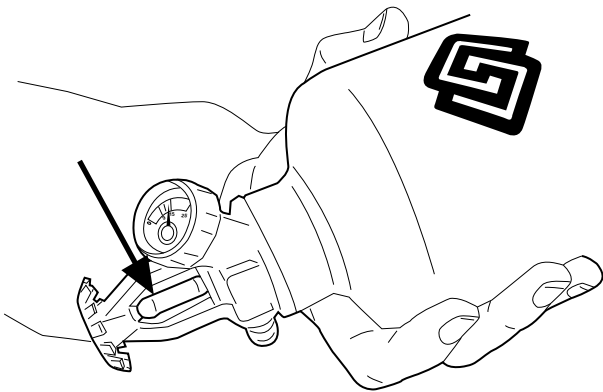

Visual check to see if the glass vial is intact. Should the device have been activated the vial will be missing, and should be replaced with a new device.

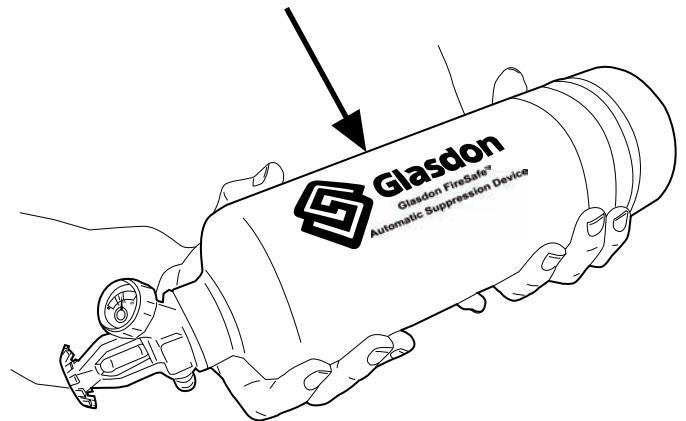

Visual check to see if there is any external damage to the device. If there are signs of corrosion the device must be removed and replaced with a new device.

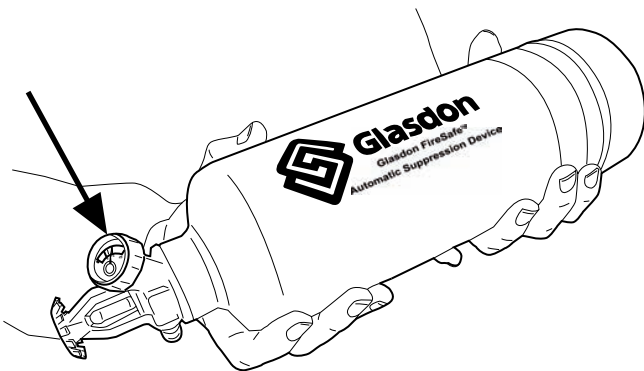

Visual check of pressure dial.
If the needle is in the green section then the device is in working condition.
If the needle is in the red sections the device must be removed and replaced with a new device.

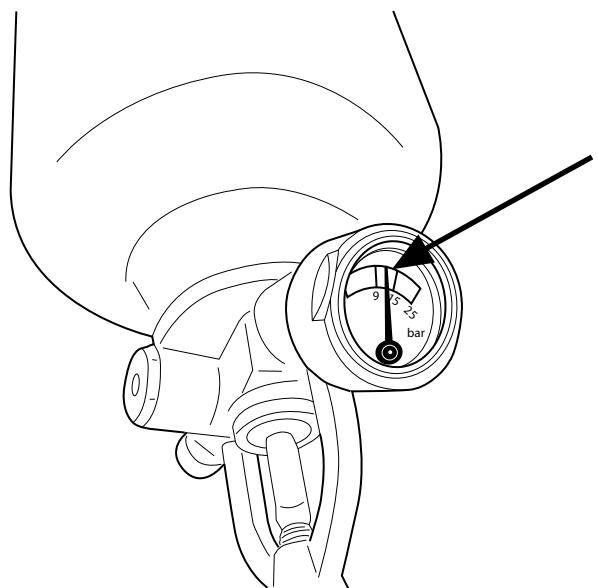

Glasdon FireSafe™ is an effective low cost auxiliary device designed to quickly extinguish fire at source but is not intended to replace primary fire prevention measures. A regular inspection and maintenance programme will ensure the device is kept in good working order. In the event that the device has been discharged it must be replaced.

REMOVING USED DEVICE

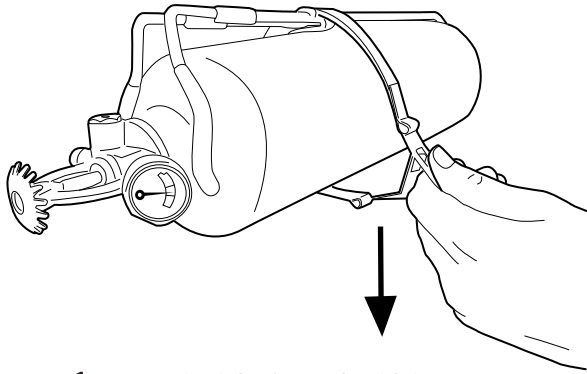

1. From inside hood of bin, release clasp on fixing bracket.

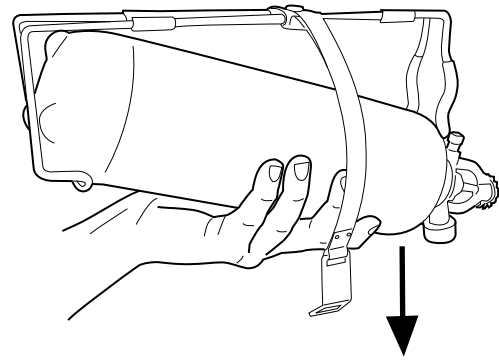

2. Release device from fixing bracket. Dispose of device. We would recommend recycling with other metal items.

INSTALLING A NEW DEVICE

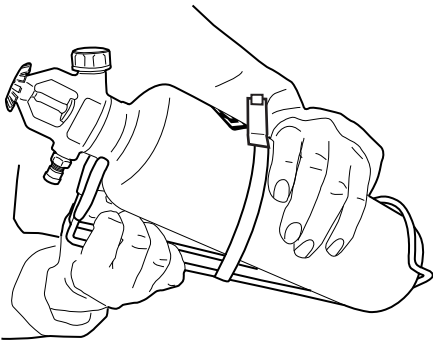

1. Remove device from new bracket as it will not be required. See above for details to remove clasp.

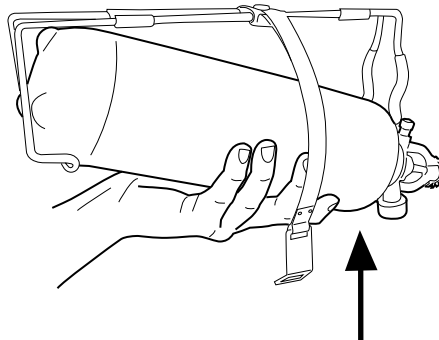

2. Offer device to bracket inside hood of bin and click into place. NOTE: The metal plate in front of the device is there to deflect the powder down into the bin.

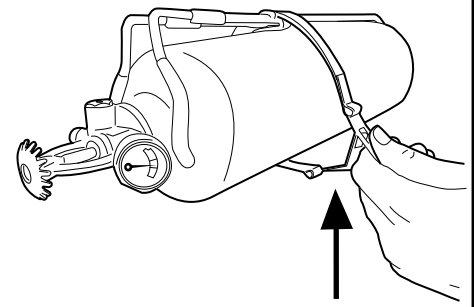

3. Place clasp around device and clip into place to secure.

TECHNICAL INFORMATION

Capacity:	1kg	Working Temp:	-20 to +60°C
Weight:	2.14kg	Discharge Time/Temp:	Under 10 secs @ 79°C ± 5°C
Height:	330mm	Operating Pressure:	12 bar @ 20°C
Width:	95mm	Contents:	ABC Dry Powder (non hazardous)
Material:	Canister - Steel	Life span:	10 years+
	Head - Brass	Disposal:	Recycle with scrap metal

 **Glasdon** AND GLASDON FIRESAFE™ ARE TRADEMARKS OF GLASDON GROUP OR ITS SUBSIDIARIES IN THE U.K. AND OTHER COUNTRIES

- A planned maintenance schedule of regular inspection is recommended, replacing components as necessary.
- Replacement components are available direct from GLASDON UK LIMITED.
- GLASDON UK LIMITED cannot be held responsible for claims arising from incorrect installation, unauthorised modifications or misuse of the product.

Issue 4 December 2011 C000/0360
© Copyright 2011
Glasdon UK Ltd reserve the right to alter specifications without prior notice.

 **Glasdon**
Glasdon U.K. Limited

Preston New Road
BLACKPOOL
Lancashire FY4 4UL
Tel: 01253 600410
Fax: 01253 792558
email: sales@glasdon-uk.co.uk
web: www.glasdon.com